

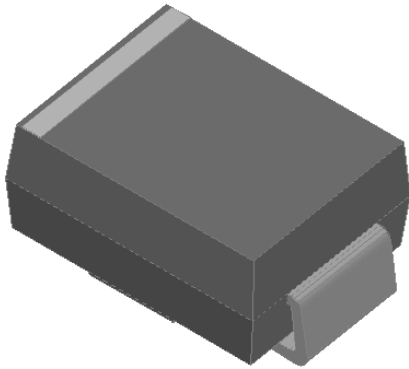

US2A THRU US2M

Surface Mount High Efficient Rectifier



Features

- Low profile package
- Ideal for automated placement
- Glass passivated chip junction
- High forward surge capability
- Super fast reverse recovery time
- Meets MSL level 1, per J-STD-020, LF maximum peak of 260 °C

Typical Applications

For use in high frequency rectification of power supplies, inverters, converters, and freewheeling diodes for consumer and telecommunication.

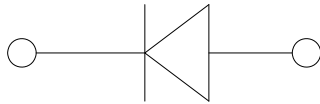

Mechanical Data

- **Package:** DO-214AA (SMB)
Molding compound meets UL 94 V-0 flammability rating, RoHS-compliant, halogen-free
- **Terminals:** Tin plated leads, solderable per J-STD-002 and JESD22-B102
- **Polarity:** Cathode line denotes the cathode end

■ Maximum Ratings (T_a=25°C Unless otherwise specified)

PARAMETER	SYMBOL	UNIT	US2A	US2B	US2D	US2F	US2G	US2J	US2K	US2M
Device marking code			US2A	US2B	US2D	US2F	US2G	US2J	US2K	US2M
Maximum Repetitive Peak Reverse Voltage	V _{RRM}	V	50	100	200	300	400	600	800	1000
Maximum RMS Voltage	V _{RMS}	V	35	70	140	210	280	420	560	700
Maximum DC blocking Voltage	V _{DC}	V	50	100	200	300	400	600	800	1000
Average rectified output current @60Hz sine wave, resistance load, TL (Fig.1)	I _O	A	2.0							
Forward Surge Current (Non-repetitive) @60Hz Half-sine wave, 1 cycle, T _j =25°C	I _{FSM}	A	50							
Forward Surge Current (Non-repetitive) @1ms, square wave, 1 cycle, T _j =25°C			100							
Current squared time @1ms≤t≤8.3ms T _j =25°C, Rating of per diode	I ² t	A ² s	10.375							
Typical junction capacitance @Measured at 1MHz and Applied Reverse Voltage of 4.0 V.D.C	C _j	pF	32			17		12		
Storage temperature	T _{stg}	°C	-55 ~ +150							
Junction temperature	T _j	°C	-55 ~ +150							



US2A THRU US2M

■ Electrical Characteristics (T_a=25°C Unless otherwise specified)

PARAMETER	SYMBOL	UNIT	TEST CONDITIONS	US2A	US2B	US2D	US2F	US2G	US2J	US2K	US2M	
Maximum instantaneous forward voltage drop per diode	V _F	V	I _{FM} =2.0A	1.0			1.3	1.7				
Maximum reverse recovery time	t _{rr}	ns	I _F =0.5A, I _R =1.0A, I _r =0.25A	50					75			
Maximum DC reverse current at rated DC blocking voltage per diode	I _R	μA	T _j =25°C	5.0								
			T _j =125°C	100								

■ Thermal Characteristics (T_a=25°C Unless otherwise specified)

PARAMETER	SYMBOL	UNIT	US2A	US2B	US2D	US2F	US2G	US2J	US2K	US2M
Typical Thermal Resistance	R _{θJ-A}	°C/W	70 ⁽¹⁾							
	R _{θJ-L}		22 ⁽¹⁾							
	R _{θJ-C}		18 ⁽¹⁾							

Note:
 (1) Thermal resistance from junction to ambient and from junction to lead mounted on P.C.B. with 0.3" x 0.3" (8.0 mm x 8.0 mm) copper pad areas

■ Characteristics (Typical)

FIG.1: I_o-T_L Cure

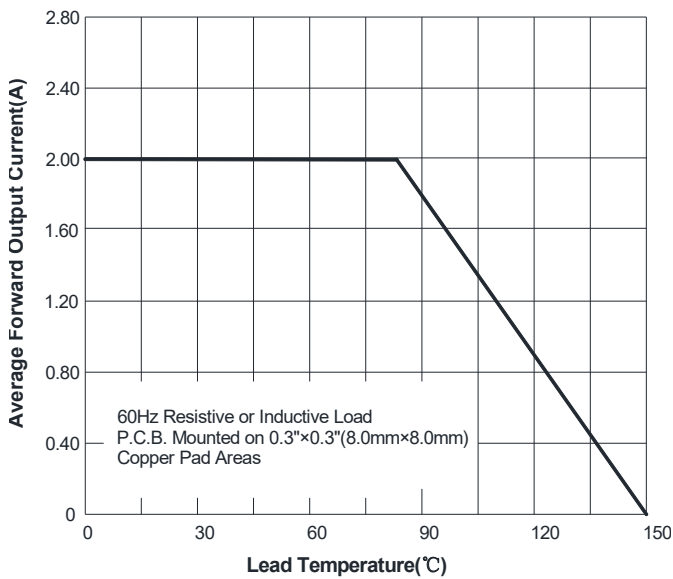
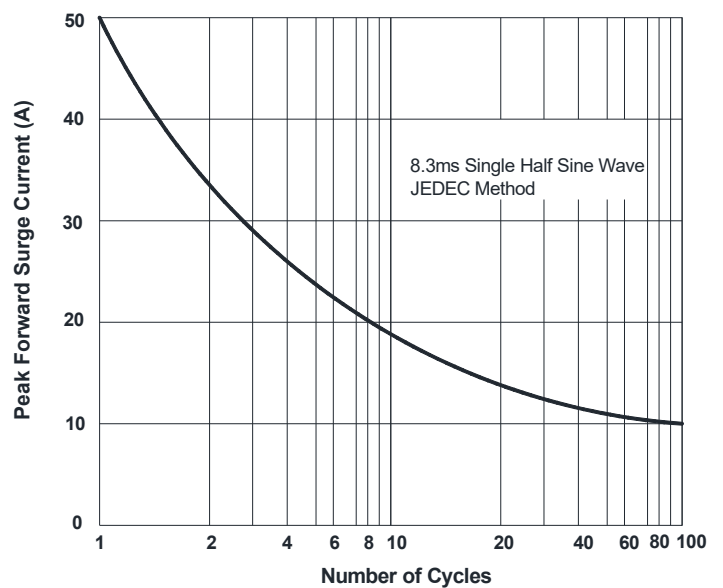

FIG.2: Forward Surge Current Capability





US2A THRU US2M

FIG.3: Typical Forward Characteristics

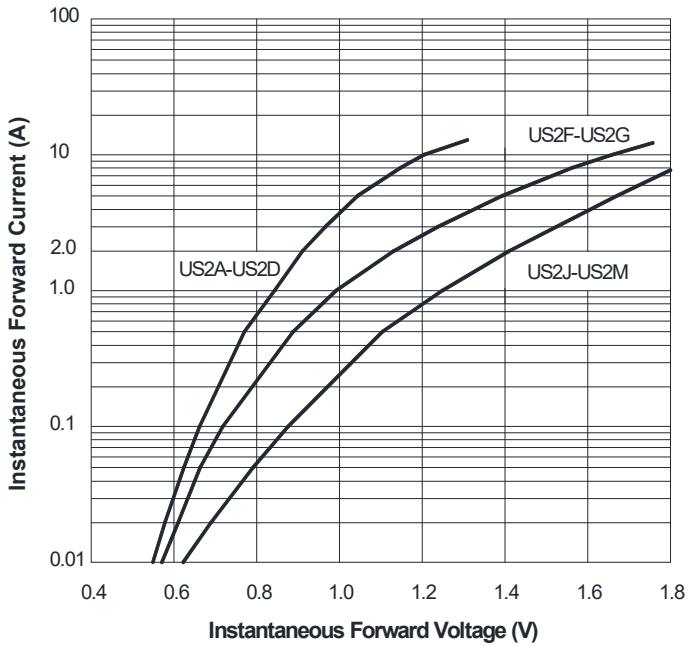

FIG.4: Typical Reverse Characteristics

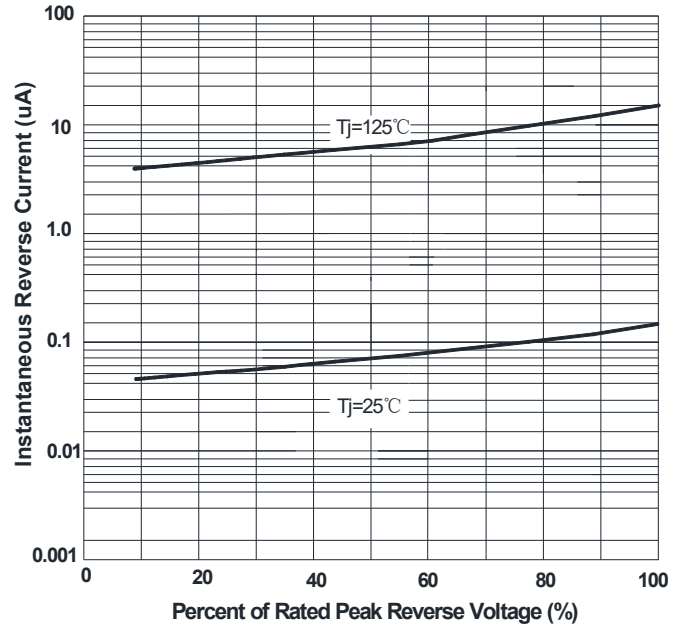
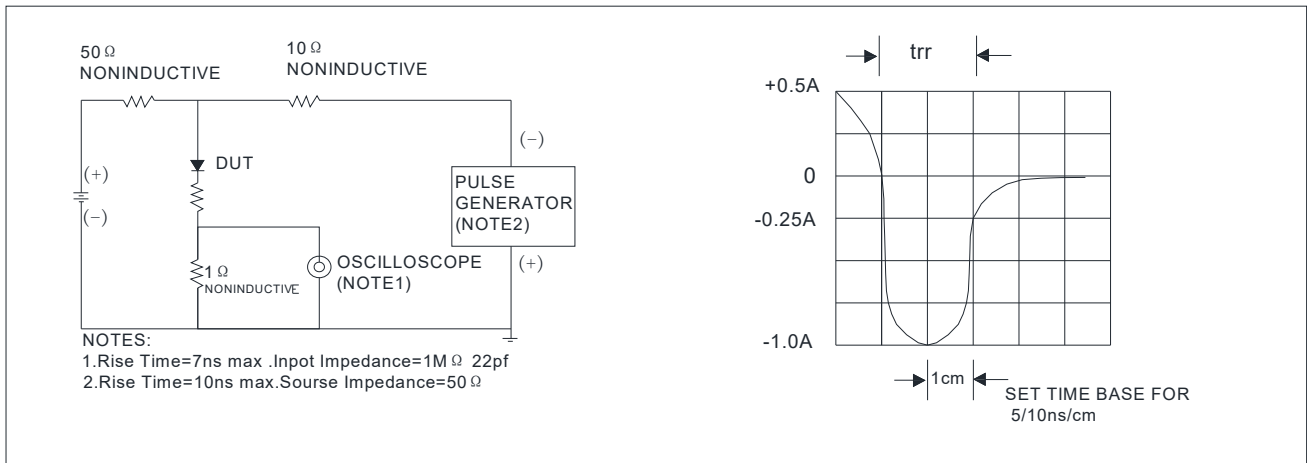

FIG.5: Diagram of circuit and Testing wave form of reverse recovery time



Ordering Information (Example)

PREFERRED P/N	PACKING CODE	UNIT WEIGHT(g)	MINIMUM PACKAGE(pcs)	INNER BOX QUANTITY(pcs)	OUTER CARTON QUANTITY(pcs)	DELIVERY MODE
US2A-US2M	F1	Approximate 0.096	3000	/	48000	13" reel
US2A-US2M	F2	Approximate 0.096	750	6000	24000	7" reel
US2A-US2M	F3	Approximate 0.096	500	4000	16000	7" reel



US2A THRU US2M

■ Outline Dimensions

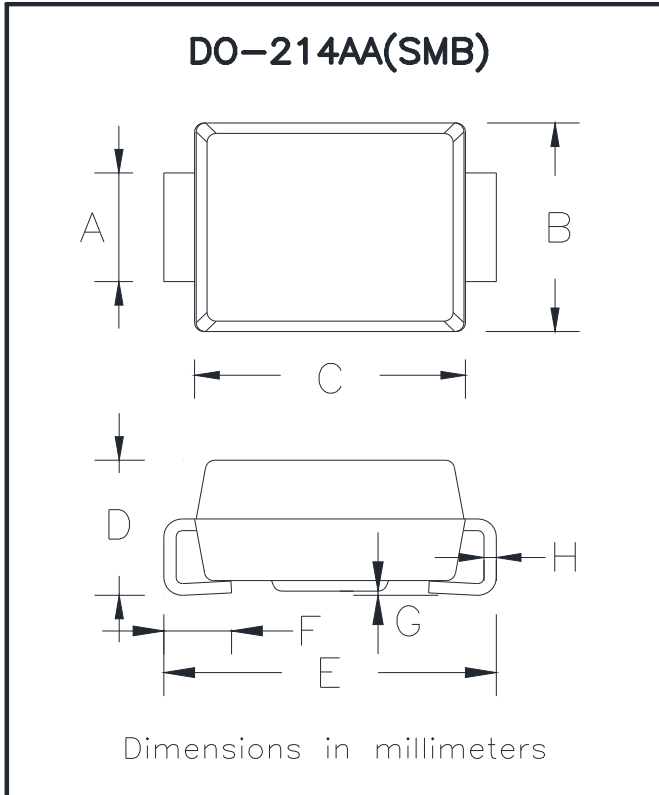

DO-214AA(SMB)		
Dim	Min	Max
A	1.85	2.15
B	3.30	3.94
C	4.05	4.75
D	1.99	2.61
E	5.21	5.59
F	0.90	1.41
G	0.05	0.20
H	0.15	0.31

■ Suggested pad layout

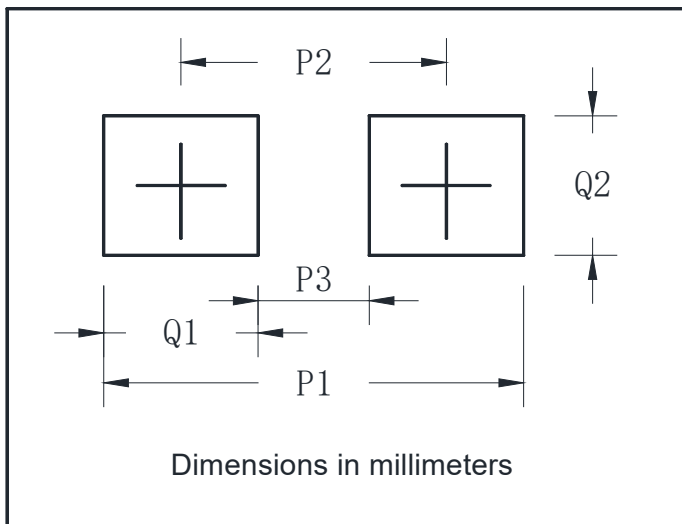

DO-214AA(SMB)	
Dim	Millimeters
P1	6.8
P2	4.3
P3	1.8
Q1	2.5
Q2	2.3



US2A THRU US2M

Disclaimer

The information presented in this document is for reference only. Yangzhou Yangjie Electronic Technology Co., Ltd. reserves the right to make changes without notice for the specification of the products displayed herein to improve reliability, function or design or otherwise.

The product listed herein is designed to be used with ordinary electronic equipment or devices, and not designed to be used with equipment or devices which require high level of reliability and the malfunction of which would directly endanger human life (such as medical instruments, transportation equipment, aerospace machinery, nuclear-reactor controllers, fuel controllers and other safety devices), Yangjie or anyone on its behalf, assumes no responsibility or liability for any damages resulting from such improper use of sale.

This publication supersedes & replaces all information previously supplied. For additional information, please visit our website [http:// www.21yangjie.com](http://www.21yangjie.com) , or consult your nearest Yangjie's sales office for further assistance.